

# POWERFORCE<sup>®</sup> HELIX TURBO REWIND Vacuum

---

USER GUIDE  
2261 SERIES

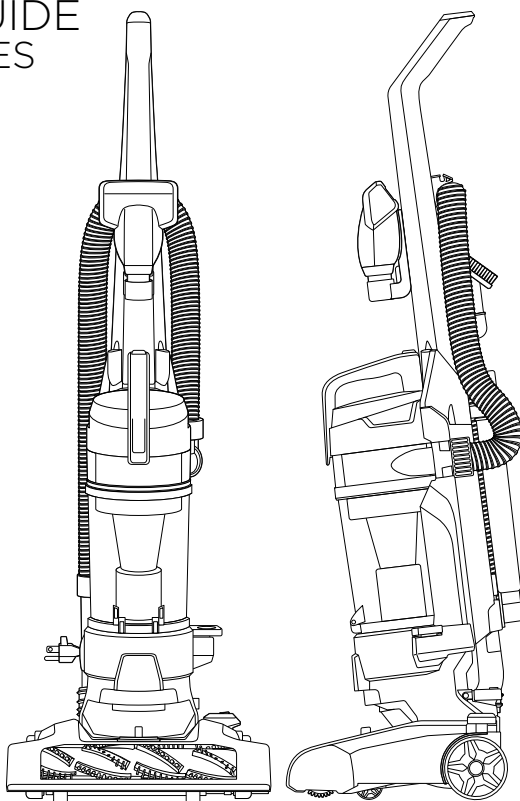

# IMPORTANT SAFETY INSTRUCTIONS

## READ ALL INSTRUCTIONS BEFORE USING YOUR APPLIANCE.

Unplug from outlet when not in use and before conducting maintenance. When using an electrical appliance, basic precautions should be observed, including the following:

### **WARNING**

#### **TO REDUCE THE RISK OF FIRE, ELECTRIC SHOCK, OR INJURY:**

- » This appliance can be used by children aged from 8 years and above and persons with reduced physical, sensory or mental capabilities or lack of experience and knowledge if they have been given supervision or instruction concerning use of the appliance in a safe way and understand the hazards involved. Cleaning and user maintenance shall not be made by children without supervision.
- » Children should be supervised to ensure that they do not play with the appliance.
- » Keep hair, loose clothing, fingers, and all parts of body away from openings and moving parts of the appliance and its accessories.
- » Unplug from electrical socket when not in use, before cleaning, maintaining or servicing the appliance, and if your appliance has an accessory tool with a moving brush, before connecting or disconnecting the tool.
- » If the supply cable is damaged, it must be replaced by the manufacturer, its service agent, or similarly qualified person in order to avoid a hazard.
- » Do not run appliance over cable.
- » Do not leave appliance when plugged in.
- » Do not use with damaged cable or plug.
- » Do not pull or carry by cable, use cable as a handle, close door on cable, or pull cable around sharp edges or corners.
- » Keep cable away from heated surfaces.
- » To unplug, grasp the plug, not the cable.
- » Do not handle plug or appliance with wet hands.
- » Turn off all controls before unplugging.
- » Hold plug when rewinding onto cord reel. Do not allow plug to whip when rewinding.
- » Plastic film can be dangerous. To avoid danger of suffocation, keep away from children.
- » Use only as described in this user guide.
- » Use only manufacturer's recommended attachments.
- » Do not immerse in water or liquid.
- » If appliance is not working as it should, has been dropped, damaged, left outdoors, or dropped into water; do not attempt to operate it and have it repaired at an authorized service center.
- » Do not put any object into openings.
- » Do not use with any opening blocked; keep free of dust, lint, hair, and anything that may reduce air flow.
- » Use extra care when cleaning on stairs.
- » Do not use to pick up flammable or combustible liquids, such as petroleum, or use in areas where they may be present.
- » Do not pick up toxic material (chlorine bleach, ammonia, drain cleaner, etc.)
- » Do not use appliance in an enclosed space filled with vapours given off by oil base paint, paint thinner, some mothproofing substances, flammable dust, or other explosive or toxic vapours.
- » Do not pick up hard or sharp objects such as glass, nails, screws, coins, etc.
- » Keep appliance on a level surface.
- » Do not pick up anything that is burning or smoking, such as cigarettes, matches, or hot ashes.
- » If your appliance has a motorized brushroll, do not leave machine running in the same spot without the handle fully upright.
- » Do not use outdoors or on wet surfaces.

## SAVE THESE INSTRUCTIONS

**FOR OPERATION ON A 220-240 VOLT A.C. 50-60 HZ POWER SUPPLY ONLY.**

This model is for household use only.

# Thanks for buying a BISSELL vacuum!

We love to clean and we're excited to share one of our innovative products with you. We want to make sure your vacuum works as well in one year as it does today, so this guide has tips on using (page 6-7), maintaining (pages 7-10), and if there is a problem, troubleshooting (page 10).

## What's in the Box?

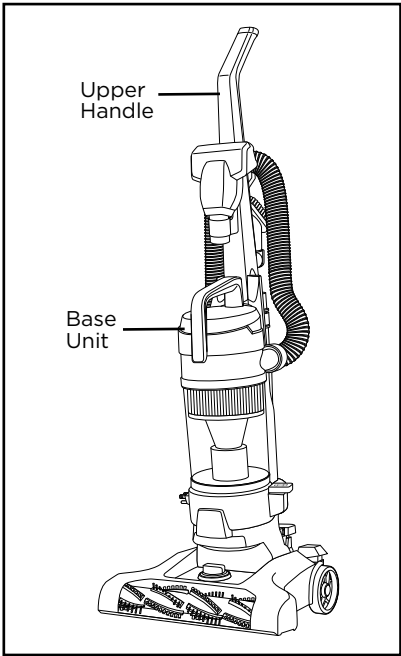
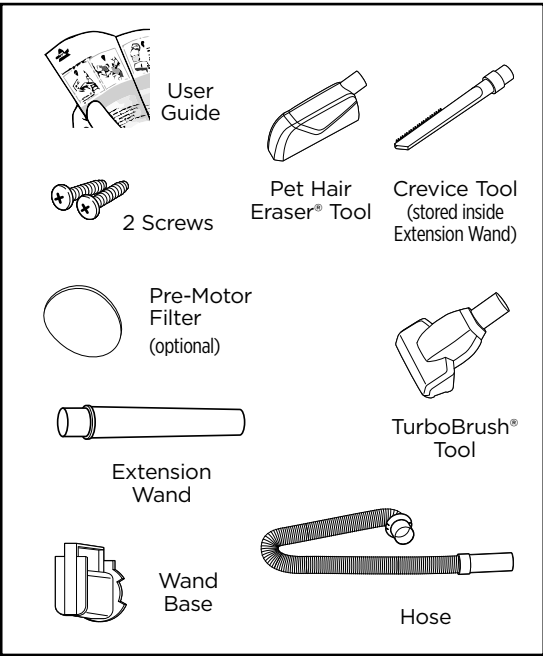

Safety Instructions.....2

Product View.....4

Assembly .....5

Operations .....6-7

Maintenance & Care .....8-10

Troubleshooting .....11

Warranty .....12

Service.....12

# Product View

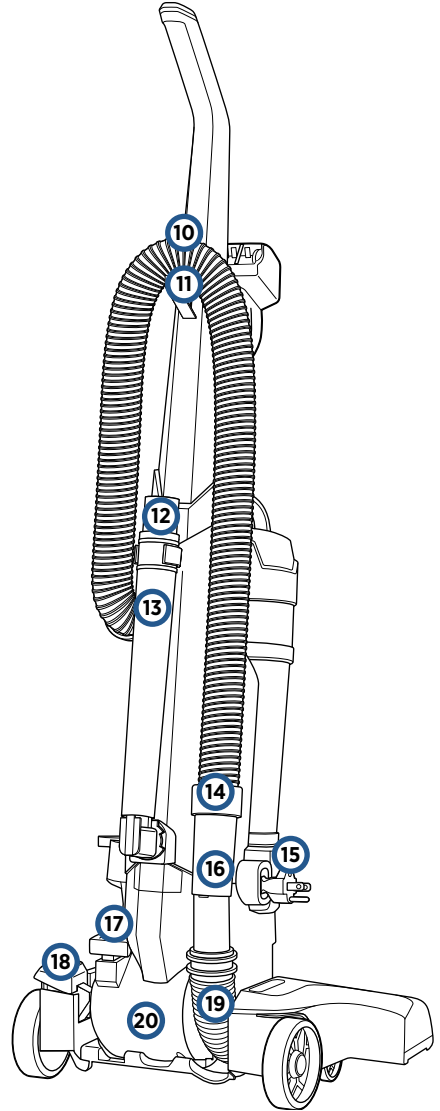
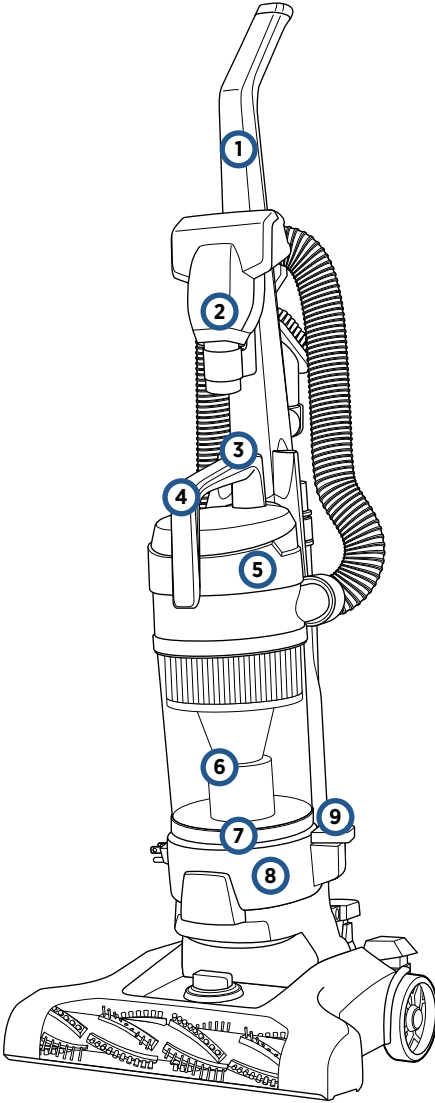

- 1 Upper Handle
- 2 TurboBrush® Tool
- 3 Tank Release Button
- 4 Carry Handle
- 5 Washable Pre-Motor Filter
- 6 Dirt Container
- 7 Dirt Container Empty Button
- 8 Washable Post-Motor Filter
- 9 Automatic Cord Rewind Button

- 11 Hose Clip
- 12 Crevice Tool (stored inside Extension Wand)
- 13 Extension Wand
- 14 Wand Base
- 15 Power Cord
- 16 Hose Wand
- 17 Power Switch Pedal
- 18 Handle Recline Pedal
- 19 Foot Hose
- 20 Product Rating Label & Serial Number

# Assembly

## ⚠ WARNING

Do not plug in your vacuum until you are familiar with all instructions and operating procedures.

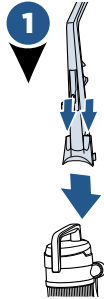

1 Place the upper handle onto the base and push it down. Then attach the handle with the 2 screws that are taped to the handle in a plastic bag.

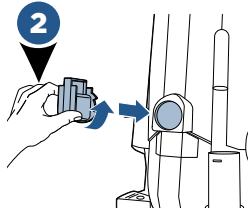

2 Next, insert the wand base and turn it to the left to lock it into place.

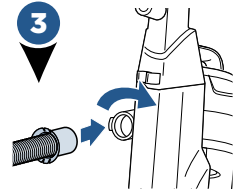

3 Next, insert the end of the hose into the back of the vacuum and twist to lock it into place.

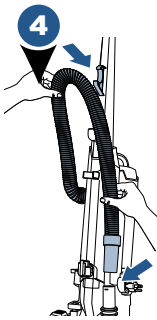

4 Now wrap the hose through the hose clip and connect the hose wand to the foot hose down at the bottom of the vacuum.

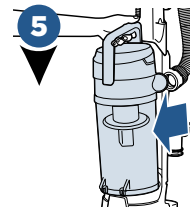

5 To replace the filter, press the tank release button and pull handle to lift dirt container away from vacuum.



6 Open the dirt container lid by lifting the release latch on the front.

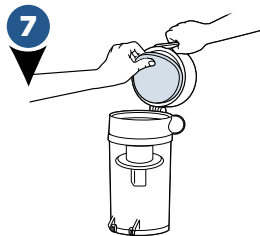

7 Remove filter in unit and replace. Return dirt tank back onto vacuum.

Put your accessory tools on the vacuum and you're ready to go!

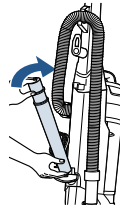

Extension Wand  
(with Crevice Tool inside)

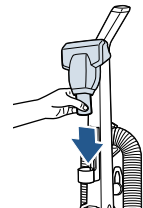

TurboBrush®  
Tool

**NOTE:** The crevice tool can be found inside the extension wand. You can remove it to use it and put it back to store it neatly out of your way when you're finished.

# Automatic Cord Rewind

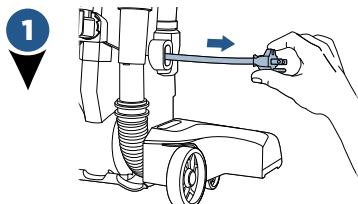

To plug your vacuum in, gently pull the cord out of the automatic cord rewind and stop at the yellow mark on the cord. Do not pull past the red mark. Once you have the desired amount of cord, plug it into the outlet.

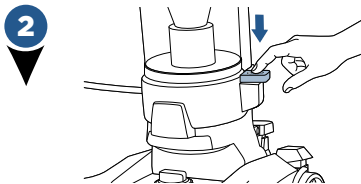

When you finish using your vacuum, unplug it from the outlet. Hold onto the plug and press the automatic cord rewind button until it's fully retracted. If the cord doesn't fully retract on the first try, pull a little bit of cord out and press the rewind button again.

# Using Your Cleaner

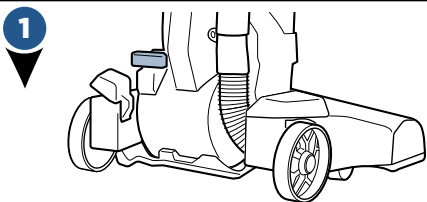

Press the red power switch ① with your foot to turn on the unit. Press it again to turn your vacuum off when you've finished cleaning.

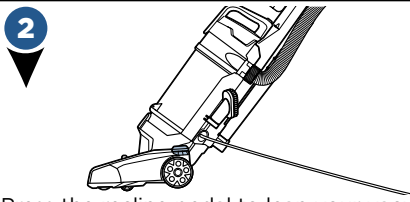

Press the recline pedal to lean your vacuum back for cleaning. To get even lower, press the recline pedal a second time. When you're finished, lean it all the way back up to lock it into the upright position.

**NOTE:** Some frieze and berber carpets have long delicate fibers or threads that may be damaged by rotating brush. Repeated strokes in the same area may enhance this condition.

## NOTICE

The floor brush will continue to rotate while you use your vacuum for above floor cleaning. To prevent carpet damage, do not lean on the vacuum or let the powerfoot tilt forward.

**⚠ WARNING** Before using your vacuum, make sure that the dirt container is in locked position and that all filters, both pre and post-filters are in place. **DO NOT** operate your vacuum without these filters.

**⚠ WARNING** The rotating floor brush continues to rotate while tools are in use. To reduce the risk of injury from moving parts, always move the cleaner with the carry handle at the front of the unit. To prevent carpet damage, do not lean on the vacuum or let the powerfoot tilt forward. Always place the cleaner on the floor with the handle in the upright position when using tools. Never place your fingers under the cleaner when it is running. Never place the powerfoot on furniture or uneven surfaces. Do not place vacuum cleaner close enough to objects to pull them into rotating brush.

## Using the Height Adjustment

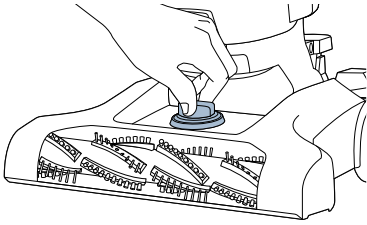

You can easily raise or lower your vacuum to adjust to different flooring types. Simply turn the knob towards the desired flooring type. If your vacuum becomes too difficult to push, just move to a higher setting.

## Using the Specialized Tools

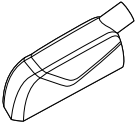

**Pet Hair Eraser®  
Tool**



**Extension Wand**

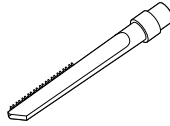

**Crevice Tool**

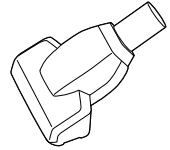

**TurboBrush® Tool**

Your new PowerForce Helix vacuum not only does a great job on your floors, it also comes with a complete set of accessory tools to make your above floor cleaning jobs easier. Just put your

vacuum in the upright position, pick the accessory tool that best fits your needs and attach it to the end of your hose. You're ready to clean base boards, curtains, upholstery and much more.

## Emptying the Dirt Container

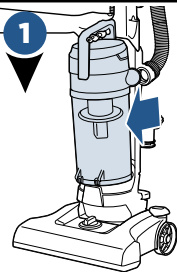

1 Press the tank release button and pull handle to lift dirt container away from vacuum.



2 Holding dirt container over a trash bin, press release button on back to open tank bottom and dump the debris.

Snap bottom back into place when empty.

## Cleaning the Pre-Motor Filter

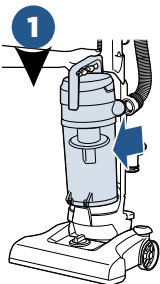

1 Press the tank release button and pull handle to lift dirt container away from vacuum.

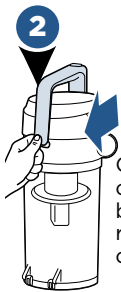

2 Open the dirt container lid by lifting the release latch on the front.



3 Remove the pre-motor filter by pulling it from the tank lid. Clean it with warm water. Allow to completely dry before returning it back into the dirt container lid.

### **WARNING**

To reduce the risk of electrical shock, turn power switch off and disconnect **polarized** plug from electrical outlet before performing maintenance or troubleshooting checks.



### **WARNING**

Do not operate the vacuum with damp or wet filters, without filters in place or with the dirt container missing. Allow components to dry before reassembling the Dirt Container.



# Cleaning the Post-Motor Filter

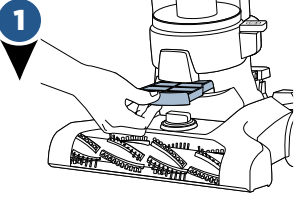

1 With dirt container removed, press filter cover release button to access post-motor filter.

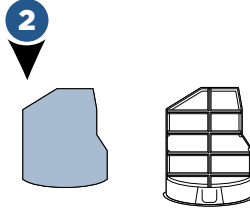

2 Clean all filters with mild detergent, rinse, and squeeze all excess water. Allow filters to dry completely before reinserting.

# Cleaning the Separator

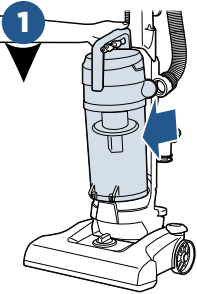

1 Press the tank release button and pull handle to lift dirt container away from vacuum.

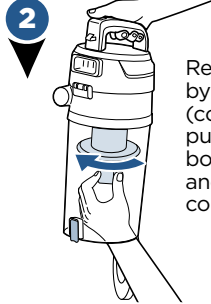

2 Remove the separator by twisting to the left (counterclockwise), then pull it out through the bottom of the tank. Rinse and dry all sections of dirt container with paper towel.

# Maintaining the TurboBrush® Tool

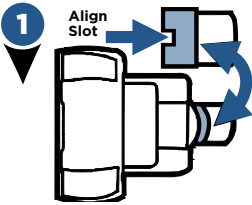

1 Twist gray collar counterclockwise, until slot appears then separate faceplate. Carefully remove brush, replace belt and brush if needed.

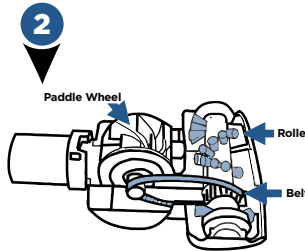

2 If paddle wheel gets dislodged, align the two clips on each side and pop into place.

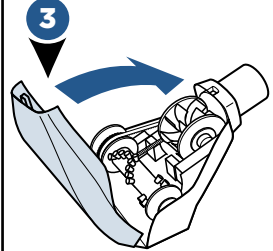

3 The faceplate will not close properly if all parts are not aligned correctly.

# Replace the Brush & Belt

1

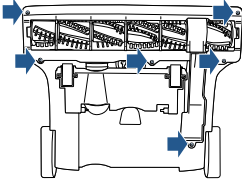

Unplug vacuum, turn over and unscrew 6 Philips head screws to remove bottom cover.

2

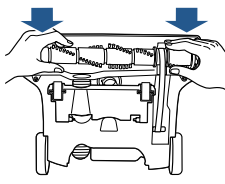

Lift roller straight out. Inspect belt, replace if it appears damaged.

3

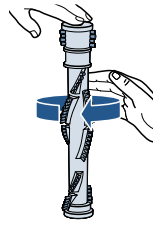

If the belt is not broken, remove roller from inside of looped belt. Inspect brush roll by placing it on its end and spin. The brush roll should spin freely, multiple times by one flick. If it doesn't, replace brush roll.

4

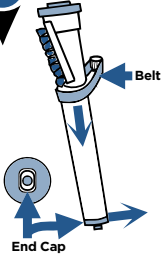

Replace the brush roll and belt by looping the belt over the motor shaft and the brush roll. Line up the end caps and pull the brush forward into place. This will stretch the belt.

5

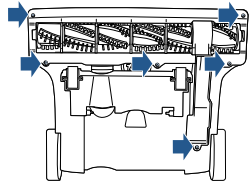

Once the brush roll is installed, place the bottom cover back on and replace the screws.

# Clearing a Clog

1

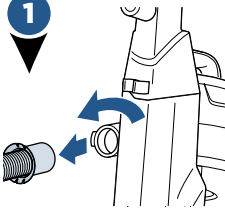

Remove the hose from the back of the vacuum by twisting it to the left. Remove any debris that may have gotten clogged.

2

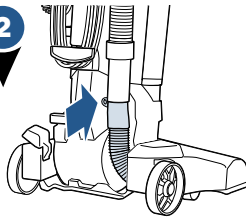

Check the foot hose on the back of your vacuum down towards the bottom. If necessary, remove the screw from the foot hose and check for clogs.

3

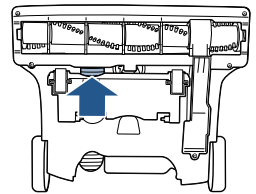

Check the air passageway on the bottom of your vacuum. Remove the bottom cover and the brush. Remove any debris.

# Troubleshooting

## **WARNING**

To reduce the risk of electric shock, turn power switch off and disconnect plug from electrical outlet before performing maintenance or troubleshooting checks.

<b>Problem</b>	<b>Possible causes</b>	<b>Remedies</b>
<b>Vacuum cleaner won't run</b>	Power cord not plugged in	Check electrical plug
	Blown fuse/tripped breaker	Check/replace fuse or reset breaker
<b>Vacuum cleaner won't pick up dirt</b>	Dirt container is full	Empty dirt container
	Filter dirty	Check, remove debris or clean
	Hose not secure	Check to be sure hose is snapped into place at both ends
	Dirt container not in place	Make sure dirt container is completely inserted and snapped into place.
	Vacuum path clogged	Visually check air passageway, hose inlet, and hose for anything that might be obstructing the vacuum path. Carefully remove blockage.
	Rotating power brush drive belt broken	Replace drive belt
	Drive belt stretched	Check drive belt area and remove obstructions. Replace drive belt if necessary
	Floor brush bristles worn	Replace floor brush
	Floor brush jammed	Remove floor brush and clean debris from brush and ends. Check drive belt for any damage
<b>Cord will not retract</b>	Power cord is knotted or twisted	Follow instructions on page 6

# Consumer Guarantee

This Guarantee only applies outside of the USA and Canada. It is provided by BISSELL International Trading Company BV ("BISSELL").

This Guarantee is provided by BISSELL. It gives you specific rights. It is offered as an additional benefit to your rights under law. You also have other rights under law which may vary from country to country. You can find out about your legal rights and remedies by contacting your local consumer advice service. Nothing in this Guarantee will replace or lessen any of your legal rights or remedies. If you need additional instruction regarding this Guarantee or have questions regarding what it may cover, please contact BISSELL Consumer Care or contact your local distributor.

This Guarantee is given to the original purchaser of the product from new and is not transferable. You must be able to evidence the date of purchase in order to claim under this Guarantee.

## Limited 2 Year Guarantee (from the date of purchase by original purchaser)

Subject to the \*EXCEPTIONS AND EXCLUSIONS identified below, BISSELL will repair or replace (with new, refurbished, lightly used, or remanufactured components or products), at BISSELL's option, free of charge, any defective or malfunctioning part or product.

BISSELL recommends that the original packaging and evidence of the date of purchase be kept for the duration of the Guarantee period in case the need arises within the period to claim on the Guarantee. Keeping the original packaging will assist with any necessary re-packaging and transportation but is not a condition of the Guarantee.

If your product is replaced by BISSELL under this Guarantee, the new item will benefit from the remainder of the term of this Guarantee (calculated from the date of the original purchase). The period of this Guarantee shall not be extended whether or not your product is repaired or replaced.

### \*EXCEPTIONS AND EXCLUSIONS FROM THE TERMS OF THE GUARANTEE

This Guarantee applies to products used for personal domestic use and not commercial or hire purposes. Consumable components such as filters, belts and mop pads, which must be replaced or serviced by the user from time to time, are not covered by this Guarantee.

This Guarantee does not apply to any defect arising from fair wear and tear. Damage or malfunction caused by the user or any third party whether as a result of accident, negligence, abuse, neglect, or any other use not in accordance with the User Guide is not covered by this Guarantee.

An unauthorised repair (or attempted repair) may void this Guarantee whether or not damage has been caused by that repair/attempt.

Removing or tampering with the Product Rating Label on the product or rendering it illegible will void this Guarantee.

SAVE AS SET OUT BELOW BISSELL AND ITS DISTRIBUTORS ARE NOT LIABLE FOR ANY LOSS OR DAMAGE THAT IS NOT FORESEEABLE OR FOR INCIDENTAL OR CONSEQUENTIAL DAMAGES OF ANY NATURE ASSOCIATED WITH THE USE OF THIS PRODUCT INCLUDING WITHOUT LIMITATION LOSS OF PROFIT, LOSS OF BUSINESS, BUSINESS INTERRUPTION, LOSS OF OPPORTUNITY, DISTRESS, INCONVENIENCE OR DISAPPOINTMENT. SAVE AS SET OUT BELOW BISSELL'S LIABILITY WILL NOT EXCEED THE PURCHASE PRICE OF THE PRODUCT.

BISSELL DOES NOT EXCLUDE OR LIMIT IN ANY WAY ITS LIABILITY FOR (A) DEATH OR PERSONAL INJURY CAUSED BY OUR NEGLIGENCE OR THE NEGLIGENCE OF OUR EMPLOYEES, AGENTS OR SUBCONTRACTORS; (B) FRAUD OR FRAUDULENT MISREPRESENTATION; (C) OR FOR ANY OTHER MATTER WHICH CANNOT BE EXCLUDED OR LIMITED UNDER LAW.

## Consumer Care

**If your BISSELL product should require service or to claim under our limited guarantee, please contact us as follows:**

### Website and Email:

[www.bissell.com.au](http://www.bissell.com.au)  
[www.bissell.co.nz](http://www.bissell.co.nz)

### Telephone:

Australia: 1300-247-735  
New Zealand: 0800-247-735

### Write:

BISSELL AUSTRALIA PTY LIMITED  
42 Rocco Dr.  
Scoresby 3179  
Victoria  
Australia

**Replacement parts and accessories are available for purchase. To purchase visit [www.BISSELL.com.au](http://www.BISSELL.com.au).**

## Visit the BISSELL website: [www.BISSELL.com.au](http://www.BISSELL.com.au)

When contacting BISSELL, have model number of cleaner available.

Please record your Model Number: \_\_\_\_\_ Please record your Purchase Date: \_\_\_\_\_

**NOTE: Please keep your original sales receipt. It provides proof of the date of purchase in the event of a Guarantee claim. See Guarantee for details.**



©2018 BISSELL Homecare, Inc  
Grand Rapids, Michigan  
All rights reserved. Printed in China  
Part Number 161-3808 04/18  
Visit our website at: [www.BISSELL.com.au](http://www.BISSELL.com.au)